

# Photosynthetic Energy and Ecological Recycling: The Architectural Potential of Algae Cultivation

GUNDULA PROKSCH

University of Washington

Ecological Design is defined as “effective adaptation to and integration with nature’s processes.”<sup>1</sup> Until recently, it has included the development of sustainable materials and employing bio-mimicry both functionally and formally.<sup>2</sup> Today, more and more projects are taking the concept further by integrating plant material and living systems directly, like living machines and algae farming. They discover sunlight-driven photosynthesis as the central force to generate renewable energy. As the primary biological process of solar energy translation that supports all life on earth, photosynthesis converts common waste products of respiration and combustion together with sunlight and water into two vital substances: sugar and oxygen.<sup>3</sup> In terms of material science, photosynthesis represents a remarkably elegant process by virtue of chlorophyll’s photosynthetic properties.<sup>4</sup> It sets the standard for any technology and material performance interacting with the energy embodied in daylight.

Photosynthesis can do even more; it sets up a co-dependency between energy production and ecological recycling. Currently, most renewable energy sources like hydroelectric, solar, wind, tidal, and geothermal, target the electricity market as “clean” energies without pollution and carbon dioxide emissions.<sup>5</sup> Photosynthesis-based systems reach beyond renewable energy production; they are capable of actively improving the health of the environment through the sequestration of CO<sub>2</sub> and wastewater treatment. Rethinking plant material as a “smart” material allows for the production of renewable energy while playing an essential role in zero-waste systems inspired by cyclical natural processes. Still underutilized in the built environment, these closed-loop systems gen-

erate a synthesis between energy generating technologies and resource sustainability (Figure 1A).

In this context, algae cultivation stands out as an extremely efficient living system because of its high productivity rates and low resource needs, as well as its ability to sequester pollutants. In comparison with terrestrial plants, algae show a higher photosynthetic efficiency and oil production. Although photovoltaic cells have a higher efficiency and energy production per area, algae-based energy is almost 30 times less expensive per unit than energy generated by photovoltaic technology. After factoring in land value, energy derived from algae can still be produced at 30% of the cost of photovoltaic-based energy (Figure 1B).

Advanced algae cultivation technologies – some still in the laboratory and scientific testing phase – instantaneously inspire architects and designers on speculative projects and design competitions. Many recent, innovative design proposals integrate algae cultivation and redefine how designers think about the relationship for sunlight, matter, and renewable energy. Given algae’s energetic potential and cleansing benefits, this paper analyzes algae farming methods, their emerging architectural applications and integration into closed-loop systems. Algae cultivation and its architectural integration promises to revolutionize ecological design and become a potent tool to address the causes of climate change.

## ALGAE FARMING

Humans have been harvesting algae for food and medicinal purposes for over 2500 years, and began

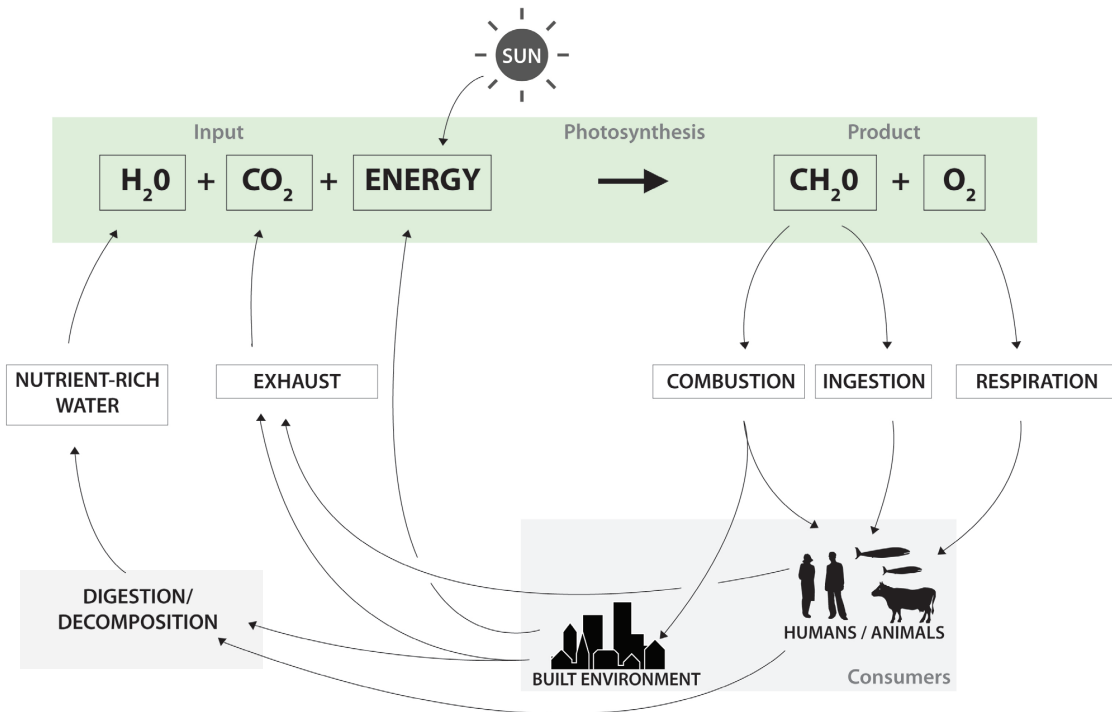

A. Closed-Loop System

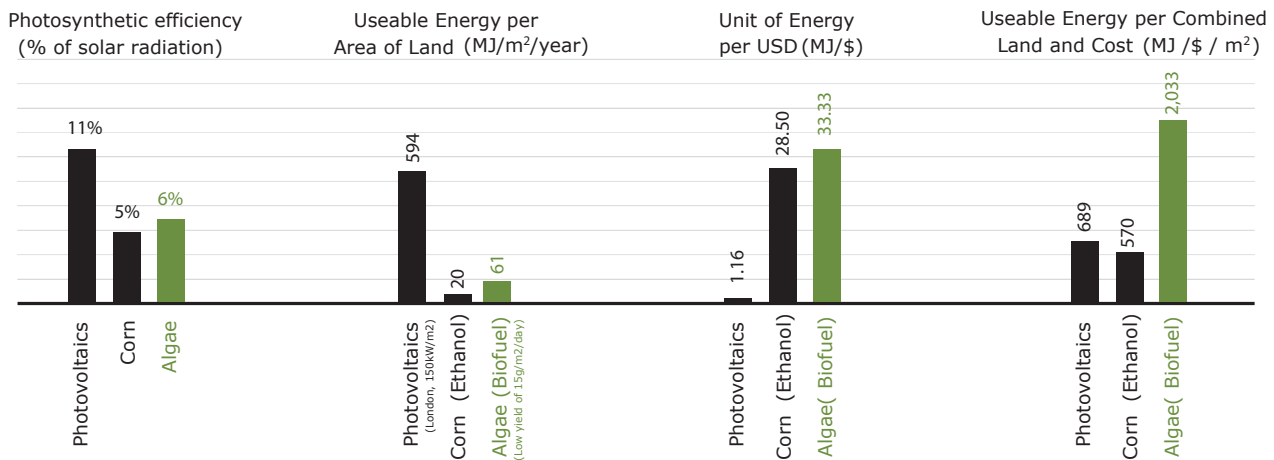

B. Comparison of Photovoltaic v. Photosynthesis

Figure 1. Photosynthesis

cultivating it approximately 300 years ago.<sup>6</sup> Currently, macro- and microalgae are commercially cultivated worldwide.<sup>7</sup> One of the earliest mentions of algae as fuel occurred in 1953 in *Algal Culture: From Laboratory to Pilot Plant*.<sup>8</sup> In his introduction to the edited volume, John S. Burlew – inspired by MIT research into rooftop micro-algae production – suggests harnessing algae’s extremely efficient photosynthesis process to produce oils, effectively

accelerating the natural process through which fossil fuels are formed.<sup>9</sup> In the 1960s Stanford University scientists Oswald and Golueke released their paper “The Biological Transformation of Solar Energy,” documenting their studies on a closed-looped algae-to-fuel production process.<sup>10</sup>

US government-supported research into the potential of algae as a biofuel surged during the en-

ergy crisis of the 1970s.<sup>11</sup> Funding dwindled in the 1980s, and government funding has only recently resurged again in response to the growing interest in alternative energies,<sup>12</sup> leading to an expansion of testing and innovation in algal fuel production and wastewater processing.<sup>13</sup> According to biologist Peer Schenk, international awareness of climate change and the need for reduced CO<sub>2</sub> emissions has focused scientific attention on the potentials of algal biofuels.<sup>14</sup> Since algae farming can occur without disrupting domestic agriculture, some governments and food industries are highly invested in its success.<sup>15</sup>

### Productivity and Resource Efficiency

Microalgae, autotrophic organisms often living as single cells and floating as plankton, are among the fastest growing, most efficient and adaptive organisms on the planet.<sup>16</sup> They can produce up to 3,000-15,000 gallons oil/acre/year.<sup>17</sup> Their very high energy content of 18.5 - 35 MJ/kg rivals coal (averages at 24 MJ/kg) and exceeds the energy density of wood, wastewater sludge, and agricultural by-product,<sup>18</sup> making them an excellent energy source. Algae have a quick harvest cycle of only 1-10 days<sup>19</sup> and can be harvested batch-wise nearly all-year-round,<sup>20</sup> providing a reliable and continuous supply. Besides energy in the form of biofuel, commercial algae cultivation has numerous uses. These include production of food, food supplements,<sup>21</sup> fish feed, bioplastics, chemical feedstock, pharmaceuticals, fertilizer, and soil enhancements.<sup>22</sup>

Algae can tolerate salt and wastewater streams and thereby greatly reduce freshwater use. In nutrient-rich, eutrophic water they thrive even more abundantly.<sup>23</sup> As a positive by-product, they clean the water as a means of pollution control. Algae farming couples CO<sub>2</sub>-neutral fuel production with CO<sub>2</sub> sequestration and O<sub>2</sub> production. Numerous studies indicate that photosynthesis performed by algae significantly contributes to a reduction of atmospheric CO<sub>2</sub> levels.<sup>24</sup> Increased CO<sub>2</sub> concentration will further increase the rate of growth as long as there is an abundance of other limiting nutrients.<sup>25</sup>

### FARMING TECHNIQUES

System designs for algae farming range from low-tech ponds to high-tech bioreactors, with each design varying the balance of yields, land, water, and energy usage, susceptibility to contamination, initial

costs, and operating costs. In all cases the growth occurs over the course of 1-10 days after which the algae mass is extracted and pressed for oil. The oil is then refined into a useable source, typically biodiesel.<sup>26</sup> Other forms of energy exploitation are possible, including biogas, methane, ethanol, and biobutanol, but the economic payback is lower.<sup>27</sup>

### Open Pond System

The open pond system is the most commonly employed growing technique today. It utilizes shallow lakes, constructed ponds or raceway ponds, in which the water is circulated by gravity or paddlewheels (Figure 2A). The major advantages of open ponds are their low construction and operation costs, but their economic margins are also lower than more controlled systems. Open ponds require large areas of land and are susceptible to contamination, evaporation losses, poor light utilization, temperature swings, and bad weather. To minimize many of the problems associated with an open system, the pond can be enclosed with a transparent or translucent barrier, which effectively turns it into a greenhouse.

### Vertical Growth Systems

To increase the productivity per areal footprint, various vertical algae growing systems have been developed. All of these are primarily capitalizing on the fact that most algae thrive best in indirect, diffuse light.<sup>28</sup> As a consequence algae can be grown in three-dimensional space rather than on a surface (like terrestrial plants), as long as the light can penetrate into the depth of the volume. The simplest vertical systems, or low-tech bioreactors, cultivate algae in clear, poly-ethylene plastic bags hung vertically from racks to expose all sides to light (Figure 2B). The individual bags are connected by circulation tubes through which water is mechanically pumped. In these closed systems the yield is higher and algae is not vulnerable to contamination. The use of simple materials keeps the construction costs low, but might also require additional structure and enclosure to protect the cultivation from weather fluctuations.<sup>29</sup>

### Closed Photo-Bioreactor Systems

Closed bioreactors are initially up to 10 times more costly than open pond systems but have 5 to 10 times higher yields per areal footprint than conventional

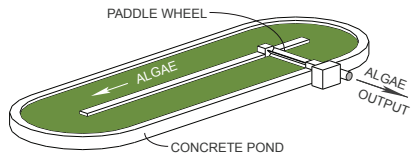

A. Open-Pond System



Source: <http://www2.hci.edu.sg/y11hci0149/website/algae-open-pond.jpg>

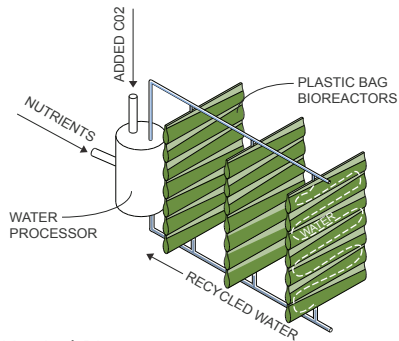

B. Low-Tech Vertical Bioreactor



Source: <http://electrictreehouse.com/wp-content/uploads/2011/01/algae-valcent-biofuel-1.jpg>

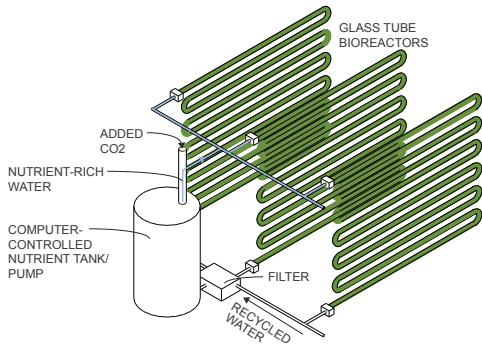

C. High-Tech Bioreactor



Source: [http://www.eworld.com/images/algae\\_bioreactor\\_tubes\\_germany.jpg](http://www.eworld.com/images/algae_bioreactor_tubes_germany.jpg)

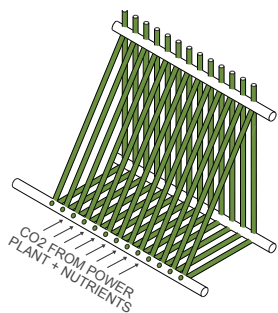

D. Experimental 3DMS Triangle Bioreactor



Source: [http://www.oakhavenpc.org/cultivating\\_algae.htm/](http://www.oakhavenpc.org/cultivating_algae.htm/) Schenk 32

Figure 2. Algae Cultivation Methods



methods. They achieve this by maximizing the absorption of nutrients and energy in a minimal volume of water under controlled conditions. The algae are typically grown in glass tubes through which water is continuously pumped. This mixing is necessary to prevent sedimentation of the algae cells and to support even distribution of CO<sub>2</sub> and O<sub>2</sub>. The design goal of all growing structures<sup>30</sup> is to maximize the surface-to-volume ratio and provide light saturation at optimal light intensities.

The world’s largest photo-bioreactor in Klötze, Germany consists of 500km of glass tubes in a 12,000m<sup>2</sup> green house. The total volume of the system is ca. 600m<sup>3</sup>; a constant flow speed of 25m per minute guarantees an optimized light exposure (Figure 2C).<sup>31</sup> A very recent bioreactor variation, the 3D Matrix System increases the photosynthetic active area per areal footprint even further.<sup>32</sup> This “airlift reactor” consists of triangular-shaped bioreactors from poly-carbonate tubing (Figure 2D). Flue gases are introduced at the bottom of the hypotenuse and flow up while the media containing the algae flows in the opposite direction. The ascending bubbles and downward current gener-

ate vortices that intensify the matter exchange (assimilation), which determines the growth rate. Even when tested under sub-optimal lighting conditions,<sup>33</sup> the reactor is one of the most productive algal cultivation systems ever built.<sup>34</sup>

**Evaluation of Algae Farming Techniques**

Despite the development of more advanced bioreactor technology, the open-pond system is still the predominant, commercial system because it is initially cheaper and nevertheless produces a profitable yield, even if it is not nearly as productive as controlled systems (Figure 3). This very land-intensive operation can be installed on marginal and non-arable land and therefore potentially opens up new economic opportunities for arid or coastal regions.<sup>35</sup> The system’s vulnerability to contaminations and the higher land cost in urban areas limits the possibility for its integration in public space and cities.

When integrating algae cultivation in cities or areas of higher density and land cost, bioreactors are the technology of choice to minimize the area needed, while increasing the yields by 5-10 times. Closed

	Yield (g/m <sup>2</sup> /day)	Land Use	Water Use	Energy Use	Contamination Threat	Initial Cost	Operating Costs
Open Pond System	Low: 10-25	High	High	Low	High	Low	Low
Bioreactor: Vertical Low-Tech	Moderate: Up to 50	Low	Low	Mod.	Low-Mod.	Mod.	Low
Bioreactor: High-Tech	High: 50-60	Low	Low	Mod.	Low	High	Mod.
“3DMS” Triangle Reactor	Very High: 80-100	Low	Low	Low	Low	Mod.	Mod.

Figure 3. Comparison of Algae Growing Systems

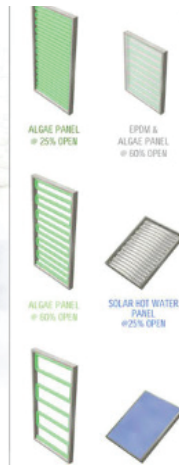

A. Algae as a Facade System - Process Zero: Retrofit Resolution

Source: <http://www.process-zero.com>

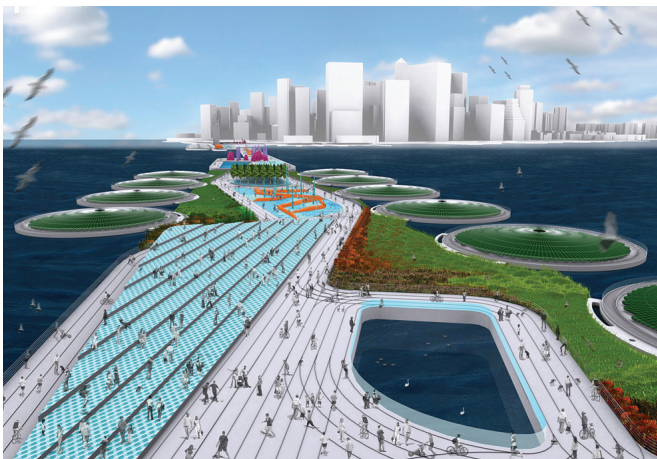

B. Algae Farming as Landscape - Carbon TAP

Source: <http://wpa2.aud.ucla.edu/info/index.php?/theprojects/winners/>

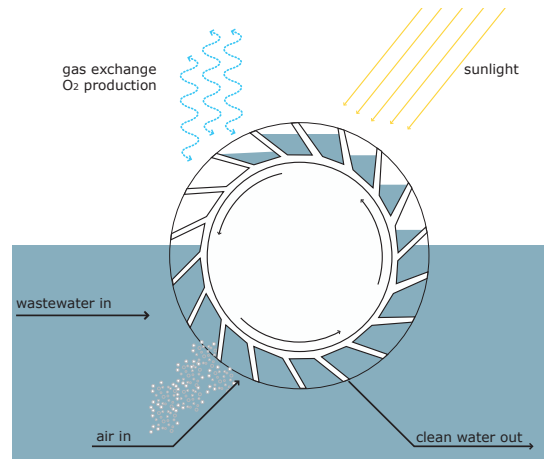

C. Wastewater Treatment - Rotating Algal Contactors RAC

Figure 4. Case Studies

systems minimize evaporation and therefore control resource input and biochemical reaction rates carefully. Depending on the construction system used, from low-tech plastic bags to high-tech fiberglass bioreactors, controlled systems require a higher initial investment. Simultaneously, the necessary structure and compactness makes them more applicable for architectural integration, both spatially and infrastructurally. Bioreactors can potentially be connected to urban infrastructures and even building systems for resource recycling and pollutant sequestration at its source and energy production where it is needed.

### SYNERGIES AND BUILDING INTEGRATION

Algae's nutritional and chemical requirements offer opportunities for establishing synergies between algae production and industrial, urban, and building utilities. Commonly, connections of algae cultivation with industrial plants that produce CO<sub>2</sub>- or nitrogen-heavy byproducts establish benefits and higher yields. Architecturally, the integration of algae farming in urban centers, in connection with urban infrastructure and building systems is equally promising.

Current case studies and investigations emphasize four different aspects and benefits of algae farming. (1) Instead of remaining a hidden, utilitarian amenity, speculative design projects have started to interweave the infrastructures of algae cultivation with cities and building systems. Algae bioreactor façades harness solar energy and reveal the new technology. (2) Controlled systems can be installed as effective CO<sub>2</sub> filters and additional power sources for buildings or neighborhoods, which utilize CO<sub>2</sub> rich exhausts. (3) Other pilot projects utilize algae's ability to thrive in nutrient rich wastewater to improve wastewater treatment practices. (4) And integrated in complex, closed-loop systems, algae cultivation can help to establish net-zero or perhaps even carbon-negative building performance.

### Solar Energy Harvesting

In 2009 the Institute of Mechanical Engineers recommended integrating algae cultivation into the existing building stock as a strategy to deal with climate change. Building-integrated photo-bioreactors are designed to efficiently collect solar radiation on the surface of buildings. Prefabricated bioreactor panels present a manageable form for al-

gae farming on the domestic and small commercial scale.<sup>36</sup> These units are more accessible from the commercial point of view and are an ideal bolt-on solution for a retrofit scenario. In addition to lowering the atmospheric CO<sub>2</sub> level and providing a natural source of energy, the algae growth infrastructure can act as thermal buffer (if integrated in a double skin façade), lead potentially to reduced energy demand, and improve building performance.

Process Zero: Retrofit Resolution, the winner of Metropolitan Magazine's The Next Generation 2011 Design Competition, translates this vision into a design proposal. It uses energy-generating algae to power a 1960s-era General Services Administration office building in Los Angeles.<sup>37</sup> A 25,000 sq ft microalgae bioreactor system generates 9% of the renovated building's power supply. A modular system of algae tubes wraps the building and absorbs solar radiation while reclaiming CO<sub>2</sub> and building wastewater to produce lipids for fuel production on-site.<sup>38</sup> The bioreactor tubes are protected from intense sunlight through a thin-film photovoltaic shading system to avoid overexposure (Figure 4A).<sup>39</sup> They are part of a full-scale closed system of holding tanks and filtration ponds to complete the bio-energy network.<sup>40</sup> The panelized, tubular algae skin expresses the alternative energy production and environmental system also architecturally and equips the building with more than a "metaphoric green cast."<sup>41</sup>

The emerging technology of bioreactors has not yet been installed on the side of the building nor integrated with high performance double skin facades. It is only a matter of time, judging from the success of other alternative energy systems, such as solar thermal, photovoltaic, and living machines, when this technology will be integrated into buildings. Currently the main concern for realizing this step is a question of scale in terms of efficiency, harvesting, and processing of the biomass.<sup>42</sup>

### Carbon Dioxide Emissions

Carbon-absorbing algae cultivation and existing carbon-emitting power plants or building exhausts can be combined to both clean emissions and increase algae yield. Several pilot programs have found that small concentrations of algae can be used to "scrub" gas emissions from power plants, absorbing as much as 85% of CO<sub>2</sub> gasses. A test system run by the Swedish energy company Vat-

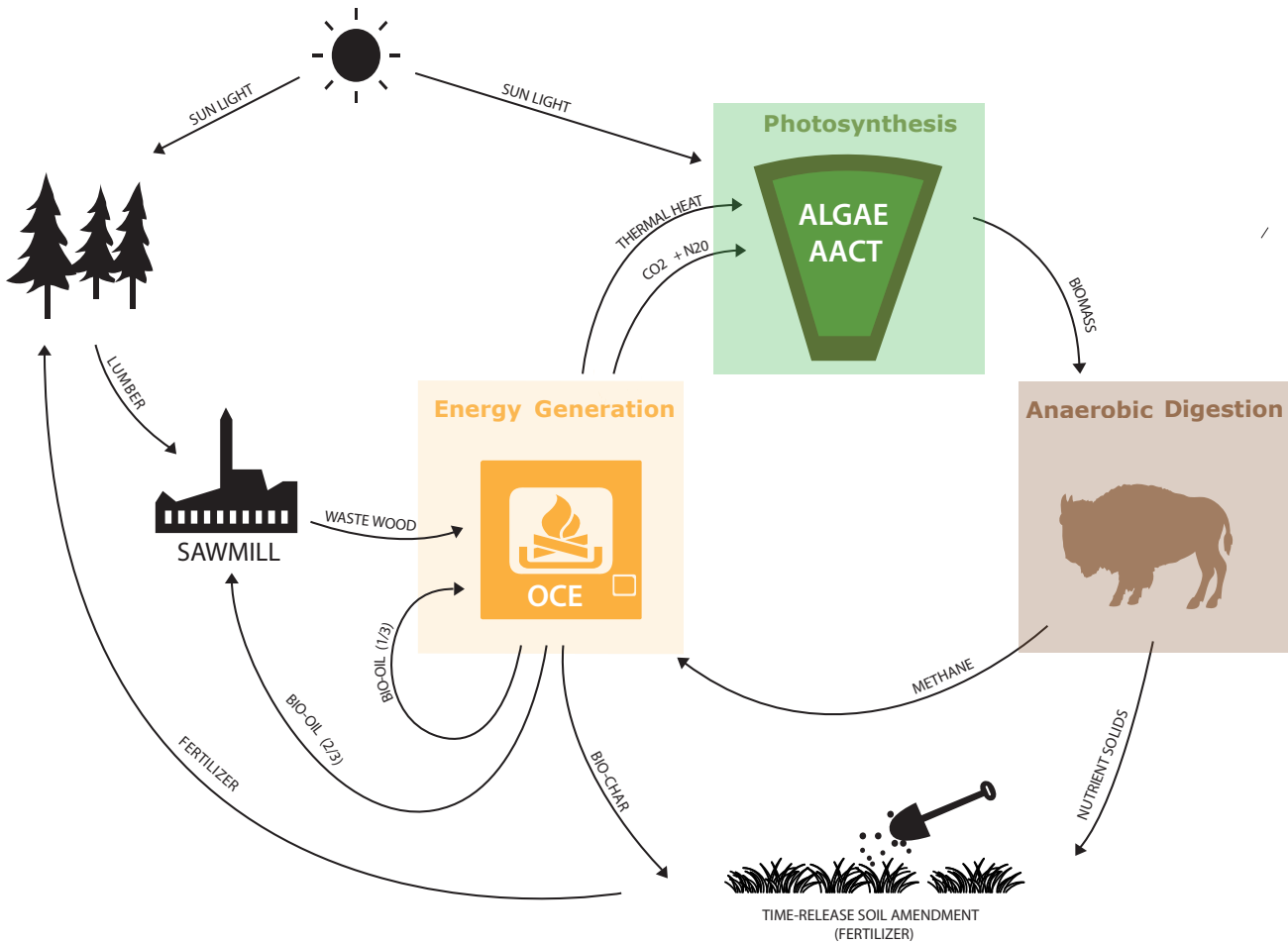

Figure 5. Green Power House - Closed-Loop System

tenfall absorbs greenhouse gas emissions from a coal-fired power plant in Germany. Flat-panel airlift reactors cultivate algae “broth” through which gas emissions are pumped. The resulting biomass is used for biofuel or fish feed.<sup>43</sup>

An innovative architectural application of this synergistic affect is Carbon TAP, the winner of UCLA’s WPA 2.0 Competition. Carbon TAP (Tunnel Algae Park) advocates taking advantage of concentrated CO<sub>2</sub> resources from underwater vehicular tunnels and urban infrastructures in cities. With the CO<sub>2</sub> exhaust of the Brooklyn-Battery Tunnel as primary case study, Carbon TAP develops a new eco-landscape or algae farm in the Upper Bay north of Governor’s Island. The algae feed off underwater “bladders” of CO<sub>2</sub> collected from the tunnel in sealed large-scale bioreactors on the surface of the bay. The farm is integrated into a public park, which doubles as an operable bridge between Manhattan and Brooklyn.<sup>44</sup>

The project is notable for its integration with existing urban infrastructure, utilizing a “out of sight” source of CO<sub>2</sub>, and generating an index for the otherwise invisible tunnel below. It imagines algae cultivation as part of a functional urban landscape, while taking advantage of the necessity of substantial CO<sub>2</sub> sources for algae production as well as its “cleaning” effect through carbon dioxide sequestration (Figure 4B).

### Wastewater Treatment

Algae’s ability to utilize the nutrients in wastewater calls for integration with water treatment processes. Solar Aquatic is one of the first living machines to use algae in translucent, light transmitting tanks for wastewater treatment. This ecologically engineered system has operated continuously since 1989 at Ocean Arks International in Rhode Island.



More recently, many municipalities are announcing plans to integrate algae technology in their wastewater treatment facilities while harnessing their additional benefits. Rotating Algal Contactors RAC's, also referred to as algaewheels,<sup>45</sup> are algae-based applications for wastewater treatment currently in the testing phase in several American cities. RAC technology employs a series of rotating photosynthetic algal contactors, which are propelled by a constant airflow and are designed specifically to grow large amounts of algae. Each wheel provides optimal conditions for algal growth while removing nutrients from the water and increasing the energy efficiency of the treatment process.

Algae and bacteria grow in a symbiotic relationship, even though algae metabolize sewage far more rapidly than bacterial treatment by converting organic matter to plant life. This natural growth process of algae removes nutrients, such as nitrates and phosphates, from the treated effluent water, which therefore can no longer harm lakes and streams. The process helps to eliminate greenhouse gas emissions by sequestering CO<sub>2</sub> and eliminating N<sub>2</sub>O as a byproduct of conventional water treatment methods. The photosynthesis process generates also oxygen, which replaces the need for costly mechanical oxidation of the wastewater. In addition, algaewheels significantly improve the energy efficiency of water treatment; they use 50 to 75% less energy than other biological processes and generate 95% less waste solids. The valuable byproduct of algal biomass is an alternative energy source, which can improve the energy balance even further. Overall, RAC technology provides one of the most environmentally friendly solutions to wastewater treatment available today.<sup>46</sup>

### Closed-Loop Systems

Algae's ability to sequester CO<sub>2</sub>, produce energy, and absorb pollutants can be integrated into a sequence of processes that build on each other by using the byproduct of one cycle as the resource for the next. Multiple interlocking cycles can create a self-sustaining, net-zero system. Green Power House (GPH) uses newly-developed Algae Aquaculture Technology (AACT) within a system that inputs two resources abundant in Montana: sunlight and woody debris waste from a lumber mill.<sup>47</sup> The system uses three separate but interrelated processes to create two important outputs: nutrient-rich soil

amendment and energy, both of which are necessary components of a successful, resource-efficient timber operation (Figure 5).

(1) Eight algae ponds of the AACT cover the floor of the GPH greenhouse. Sunlight, CO<sub>2</sub> and N<sub>2</sub>O from the Organic Carbon Engine (OCE) provide nutrients for algae growth. Ponds are managed and harvested separately for maximum yield. (2) The anaerobic digester breaks down algae sludge harvested from ponds inside the greenhouse by using a process similar to that found in a buffalo's stomach to produce methane and nutrient-rich solid matter (digestate). The methane is used in the OCE to start gasification process. (3) The Organic Carbon Engine (OCE) converts waste wood into biochar, bio-oil, CO<sub>2</sub>, and N<sub>2</sub>O through gasification (pyrolysis). Waste gases are pumped into the algae ponds to accelerate algae growth and increase yields while simultaneously managing CO<sub>2</sub> emissions and creating a carbon-negative cycle<sup>48</sup>.

### CHALLENGES AND LIMITATIONS

The primary challenge algae cultivation faces when optimized for efficient energy and biofuel production is the question of scale. All currently existing operations work at relatively large scale.<sup>49</sup> For large operations the availability of all resources in one place – a concentrated CO<sub>2</sub> source, water, infrastructure, and land – is critical. Other important factors in this context are the high costs of harvesting and processing the algal biomass.<sup>50</sup> Algae can be produced in large quantities, but at the same time efficient harvesting needs to be available on site. Multiple tons of biomass must be harvested, processed, and refined almost daily. A selected location needs to be able to handle both, the production of algae as well as the processing of the end product.

The Institute of Mechanical Engineers suggests the large-scale introduction of algae cultivation into the built environment by integrating growth facilities into the urban fabric.<sup>51</sup> While the growing happens dispersed on available vertical and horizontal surfaces in discrete photo-bioreactors, a local, combined energy center contains and coordinates all processing and generation. The center is linked up to a district heating/cooling network as well as the grid for surplus production. Mixed-use developments with an energy demand profile sufficient to merit running a combined heat and power unit for more

than 5,000hrs/yr are ideally suited for this scheme. The implementation of this concept is scalable, but larger processing plants and systems will benefit most from economies of scale.<sup>52</sup>

To set scale in perspective, experts suggests that algal cultivation is primarily indicated where algae performs multiple functions, such as CO<sub>2</sub> sequestration, wastewater treatment, and nutrient recovery, because expenses for cultivation and harvesting do not have to be adequately offset by increased fuel production alone.<sup>53</sup> Given the growing architectural interest in algae integration, more research needs to be conducted on the efficiencies and scale of algae farming. An interesting question remains, in how far algae cultivation could happen on smaller scale and in smart networks following the trend of other alternative energy production towards decentralization.

## CONCLUSION

The architectural integration of algae cultivation opens a new dimension to ecological design by combining carbon neutral/negative energy production with ecological recycling of environmental pollutants. With its high ecological performance, algae production generates a multi-fold contribution towards improving the health of the environment. On the infrastructural scale, it improves the environmental footprint of power plants, industrial processes and large urban infrastructures. As demonstrated in design projects for innovative parks, it can become part of the urban landscape. Through urban and building integration, it can be connected to the waste stream and exhaust of the existing urban infrastructure. On the smallest scale, algae cultivation can potentially improve the performance of individual buildings, for example, through the integration of novel façade technologies.

Besides sequestering CO<sub>2</sub>, algae can mitigate other environmental challenges. It treats wastewater by using the pollutants as nutrients for its own growth. Algae can grow in waste and salt water and can be cultivated on marginal land<sup>54</sup>; therefore it does not contribute to the strain on freshwater resources or compete for arable land with other crops. On the contrary, as a source for fertilizer and soil amendment, it helps to re-establish the nutrient cycle, improve depleted soil, and reduces the petrochemical fertilizer production.

These unique benefits of algae cultivation initiate a rethinking of the relationships between sunlight, alternative energy and material recycling. Although currently monopolized by industrial-scale operations focusing on the efficiency of biofuel production, the recent interest by architects and designers in algae technologies shows that these new relationships have strong potential for future development of algae-integrated buildings and closed-loop systems to mitigate climate change.

## ENDNOTES

- 1 Van der Ryn, Sim, and Stuart Cowan, *Ecological design* (Washington, D.C.: Island Press, 1995), 18.
- 2 Benyus, Janine M., *Biomimicry: innovation inspired by nature*. (New York: Perennial, 2002)
- 3 Van der Ryn, 32.
- 4 Lim, C. J., and Ed Liu, *Smartcities + eco-warriors*. (Abingdon [England]: Routledge, 2010), 19.
- 5 Schenk, Peer, Skye Thomas-Hall, Evan Stephens, Ute Marx, Jan Mussgnug, Clemens Posten, Olaf Kruse, and Ben Hankamer, "Second Generation Biofuels: High-Efficiency Microalgae for Biodiesel Production," *BioEnergy Research*, 1 (1) 2008: 20.
- 6 Tseng, C. K., "Commercial cultivation," in *The Biology of Seaweeds*, ed. C. S. Lobban and M. J. Wynne. (Oxford: Blackwell Scientific Publication, 1981), 680-725.
- 7 See: *Modern Uses of Cultivated Algae*, <http://www.ethnoleaflets.com/leaflets/algae.htm> (assessed Sep. 3, 2011)
- 8 Burlew, John S., ed. *Algal Culture: From Laboratory to Pilot Plant*. (1953)
- 9 *ibid*, 6-8
- 10 Oswald, W. J., and C. Golueke, "Biological Trans-formation of Solar Energy," *Advances in Applied Microbiology*, 2 (1960): 223-262.
- 11 Benemann, John R., *Overview: Algae Oil to Biofuel*, NREL (February 2008), (accessed Sep. 10, 2011)
- 12 Pienkos, Philip T. and Al Darzins, *The Promise and Challenges of Microalgal-Derived Biofuels*, AFDC (May 2009), (accessed Sep. 10, 2011) 436-437.
- 13 Biomass Program: *Algal Biofuels*, USDOE, (accessed Sep. 10, 2011)
- 14 Schenk, 21
- 15 Biomass Program
- 16 See: <http://electrictreehouse.com/tag/bioreactor/> (assessed Sep. 3, 2011)
- 17 Suzanne Goldenberg, "Algae to Solve pentagon's fuel problem," *Guardian.co.uk*, Feb. 13, 2010. <http://www.guardiannews.com/> (assessed Sep. 5, 2011)
- 18 IMECHE Report: *Institution of Mechanical Engineers, Geo-Engineering Giving Us the Time to ACT?*, London, August 2009, 16.
- 19 Schenk, 24.
- 20 *ibid*, 20.
- 21 Food supplements and ingredients such as

- omega-3 fatty acids or natural food colorants and dyes are produced from algae.
- 22 <http://en.wikipedia.org/wiki/Algaculture> (assessed Sep. 5, 2011)
- 23 *ibid*, 26.
- 24 <http://www.algomed.de> (assessed Sep. 3, 2011)
- 25 IMECHE Report, 16.
- 26 The algae oil can also easily be mixed with other fuels such as gasoline or jetfuel.
- 27 Schenk, 28.
- 28 To optimize the photosynthetic reaction, most algae species require indirect, middle-intensity light levels, which equal a light intensity of 1,000-10,000 lux. Direct sun light causes low efficiencies, photo-inhibition, or even photo-bleaching (Schenk, 30).
- 29 Kizililsoley, Mustafa and Helvacioğlu, Soner. "Microalgae Growth Technology Systems." Soley Institute Presentation at IIMSAM, New York, NY, 2008, 27.
- 30 Four geometries are commonly utilized for photo-bioreactors: tubes, plate, annular and "plate airlift," each differently prioritizing surface area, light penetration, and water mixing speed (Schenk, 33).
- 31 <http://www.algomed.de> (assessed Sep. 5, 2011)
- 32 Pulz, Otto, "Evaluation of GreenFuel's 3D Matrix Algae Growth Engineering Scale Unit." IGV Institut für Getreideverarbeitung, Sep. 2007, 6.
- 33 Schenk, 31.
- 34 In field tests, it exhibited an average productivity of 98 g/m<sup>2</sup>/day (Pulz, 11).
- 35 Schenk, 23.
- 36 IMECHE Report, 16.
- 37 See: Giving new meaning to 'livingwall'... [http://www.worldarchitecturenews.com/index.php?fuseaction=wanappln.projectview&upload\\_id=16709](http://www.worldarchitecturenews.com/index.php?fuseaction=wanappln.projectview&upload_id=16709) (assessed Sep. 5, 2011)
- 38 *ibid*
- 39 <http://www.process-zero.com/> (assessed Sep. 4, 2011)
- 40 [http://www.metropolismag.com/nextgen/ng\\_story.php?article\\_id=4726](http://www.metropolismag.com/nextgen/ng_story.php?article_id=4726) (assessed Sep. 10, 2011)
- 41 *ibid*
- 42 Bioreactor expert René Wijffels of Wageningen University in the Netherlands states that his main concern for integrating algae production in buildings is whether the surface area is significant enough.
- 43 See: MNN: Power plant testing CO<sub>2</sub>-scrubbing algae, <http://www.mnn.com/earth-matters/climate-weather/stories/power-plant-testing-co2-scrubbing-algae> (assessed Sep. 5, 2011)
- 44 See: PORT CARBON TAP competition boards, <http://portarchitects.com/project/urban-algae/> (assessed Sep. 4, 2011)
- 45 <http://www.algaewheel.com/algaewheel-technology/> (assessed Sep. 10, 2011)
- 46 <http://continuingeducation.construction.com/article.php?L=227&C=698&P=1> (assessed Sep. 10, 2011)
- 47 Green Power House is located at the lumber mill of F.H. Stoltze Land and Lumber Co. near Columbia Falls, Montana.
- 48 See: BioCycle article: [http://www.jgpress.com/archives/\\_free/002388.html](http://www.jgpress.com/archives/_free/002388.html) (assessed Sep. 5, 2011)
- 49 See: Benemann, John R., MICROALGAL BIOFUELS: A BRIEF INTRODUCTION, <http://advancedbiofuelsusa.info/wpcontent/uploads/2009/03/microalgae-biofuels-an-introduction-july23-2009-benemann.pdf>, (assessed Sep. 6, 2011)
- 50 *ibid*
- 51 IMECHE Report, 14-19.
- 52 IMECHE Report, 17.
- 53 Benemann
- 54 Schenk, 23